

QUALITROL® 609 PDM

Transformer partial discharge monitor



Turn key condition monitoring solution to prevent costly failures and extend asset life of transformers

- Accurate and early incipient fault detection ensures reliable operation and reduces supply outages
- Creates highly accurate reports on asset condition hence reduces maintenance cost
- Monitors multiple transformers simultaneously resulting in higher return on investment
- Robust design and excellent interference immunity for measurements under difficult environmental conditions

Product Summary

Description The 609 PDM system is an on-line partial discharge (PD) monitoring system for power transformers, based on industry accepted UHF technology.

Application The 609 PDM is used to continuously assess the performance of insulation in a power transformers so that corrective actions can be taken before any failure occurs. The information gained from the system is used for condition based maintenance decisions to optimise maintenance expenditure.

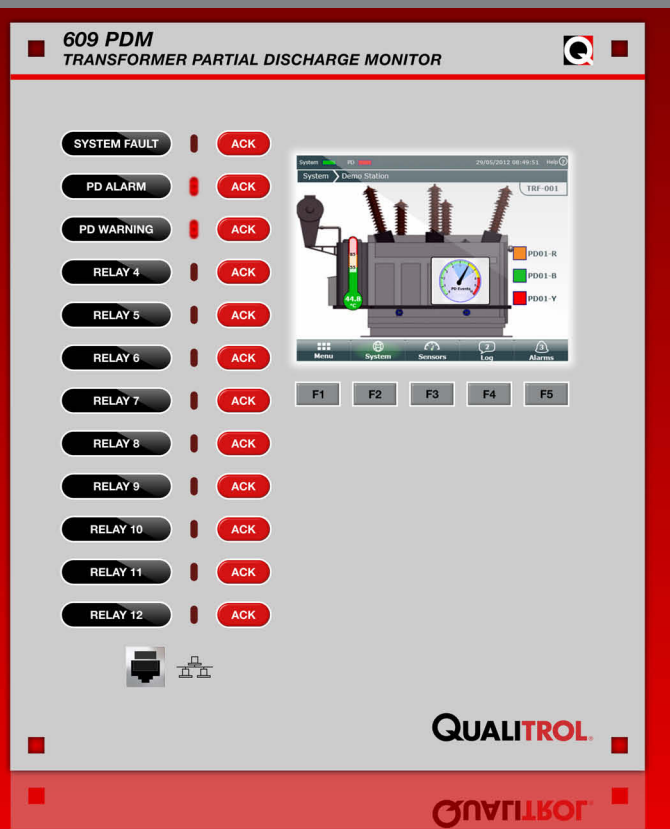

QUALITROL®
Defining Reliability

QUALITROL 609 PDM Transformer partial discharge monitor

Turn key condition monitoring solution to prevent costly failures and extend asset life of Transformers

- The 609 PDM is a complete PD monitoring package that includes sensors, cables, data acquisition unit, processing unit (CPU) and software
- Commissioning, training and diagnostic services through our expert engineers and researchers
- Condition monitoring of insulation of power transformer whilst asset is still in service
- Calibration facility for sensors to verify proper operations

Accurate and early fault detection ensures reliable operation and reduces supply outages

- Outstanding sensitivity and accuracy (-75 dBm) of UHF measurements
- Built-in sensitivity of -75 dBm enables better PD analysis
- Wide bandwidth of 300 to 1500 MHz
- Higher sample resolution (256 samples per cycle) improves definition of PD events
- Amplitude comparison helps in approximate localisation of PD fault
- Easy alarm setting configurable for each channel separately

Creates highly accurate reports on asset condition hence reduces maintenance cost

- Integrated Reporting: Need based customizable reports created automatically in a single document
- Flexible PD event visualization, including PRPD (Phase Resolved Partial Discharge), PRPS (Phase Resolved Pulse Response), POW (Point on Wave) and STT (Short Term Trend)
- PRPD recording facility helps in analyzing historic data
- Fast and easy access of data in generating reports

Monitors multiple transformers simultaneously resulting in higher return on investment

- Suitable for 1 to 24 channels depending on the transformer location and monitoring sensors per transformer
- External OCU's can be connected to the same 609 base unit
- No need for any additional cabinet, CPU and software

Robust design and excellent interference immunity for measurements under difficult environmental conditions

- Rugged sensors and connectors with IP66 rating
- Built-in display and remote client enable safe operations in difficult environmental conditions
- Noise gating by external signal antenna (optional)
- Transient protection for each channel

Advanced HMI provisions (intelligent data handling, display and interpretation)

- Built-in LCD screen with touch screen based interface
- Automatic self-check of PDM with faults logged and alarmed
- 2D and 3D display of PD signals in multiple formats (PRPD, PRPS, POW and STT)
- Trend analysis facility on stored PD data
- Self-test functionality for each channel saves time in diagnosing system fault
- Export functions for PD results / reports
- Remote client interface with integrated software to view, analyse and display PD events and trending

Qualitrol Expert PD analysis services

- Highly experienced and industry known experts to analyse PD events
- PD analysis report (on demand) prepared by Qualitrol experts
- Support available on system installation, testing and PD analysis

Turnkey condition monitoring solution...



Flexible installation and configuration options to meet customer expectations

- Very rapid and easy deployment
- Sensors can be fitted to available inspection hatch, drain valve or manhole as retrofit
- Easy configuration of system (offline / online) using touch screen interface
- Required modules and features already installed into the system
- Support to multiple operating systems (Windows XP, Windows 7)

Smart and quick real time alarming / alerting mechanism

- Easily programmable alarm criteria and rule engines
- Hardwired alarms for SCADA and local user interface
- Real-time monitoring of events with time accuracy of 1 millisecond
- Facility to alert through SMS, email, IEC 61850, substation RTU

Remote monitoring and configuration

- Secure client interface provides functionality to monitor and archive alarms and event information
- Facility to configure system remotely
- Multiple communication methods (Ethernet, RS-485, RS-232)
- Built-in support for Modbus, DNP3.0 and IEC 61850 protocols

Expandable and field upgradable without reconfiguration

- Designed for future expandability and ability to take inputs from sensors with 4 -20 mA output
- 16 GB SLC SSD storage capable of being upgraded if required
- Supports addition of future client applications
- Easily changeable front panel alarm layout

Other key benefits

- Designed to meet highest security standards, including NERC cyber-security standards
- Built-in time synchronization through NTP/SNTP

Why UHF (Ultra High Frequency) technology?

- UHF technology is industry proven technology for online monitoring of partial discharge in insulations of HV apparatus
- The sensitivity is higher than any other kind of PD measurement e.g. DGA, Acoustic, or conventional measurement
- Immediate detection of partial discharge makes it ideal for online monitoring and detects PD earlier than DGA (Dissolved Gas Analysis)
- Excellent interference immunity compared to acoustic and conventional measurements

Why Qualitrol DMS?

- Qualitrol DMS is the pioneer in UHF based PD measurement technology
- Qualitrol DMS has more than 20 years of experience in supplying UHF based PD monitoring systems to utilities across the world
- Proven and tested hardware and software systems for more than 20 years
- Industry known expert service in PD analysis and reporting
- Long term serviceability assurance and upgrade options to the 609 PDM system

...from the world leader in PDM

QUALITROL 609 PDM Transformer partial discharge monitor

System components

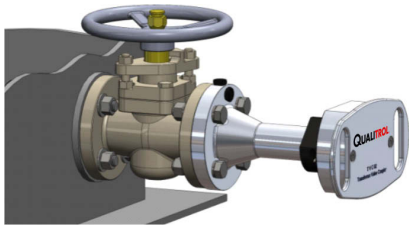

▲ Oil drain valve sensor

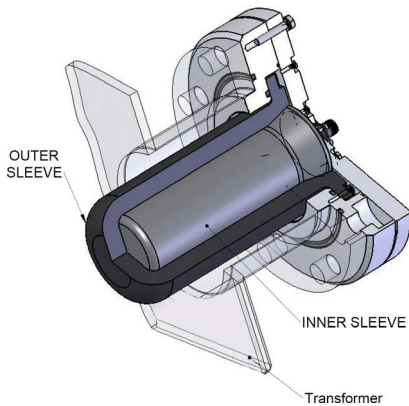

▲ Window sensor (patented)

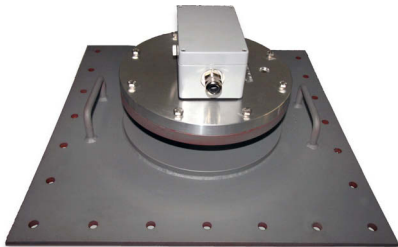

▲ Sensor - retrofit to hatch cover



UHF sensor (coupler)

- UHF sensors are the key components of any PDM system. They capture the UHF signals induced from PD pulse and send to the data acquisition system for interpretation.
- The 609 PDM can be connected with any available UHF sensor internal, window or drain valve sensor. The system can be scaled from one sensor to 24 sensors.
- In new transformers the sensors are usually fitted internally, inside the tank wall (internal sensors). They act as antennas picking up UHF signals induced from PD. Complete protection for sensitive electronics of the 609 PDM is assured by fitting an external DMS protector which shunts dangerous voltages to earth.
- For retrofitted systems, external sensors are fixed in either hatch covers or drain valve.
- Qualitrol DMS can custom-design all types of UHF sensors for particular applications and calibrate them to ensure they meet the users specification for sensitivity and bandwidth.

Optical Converter Unit (OCU)

- Each OCU takes the signal from the UHF sensors and applies filtering to reject interference (noise) that can result from broadcast signals, discharges in nearby air-insulated equipment and other sources. The characteristic of the UHF pulse is then sent to the Equipment Cabinet.
- Additional fibres within the cable are used for OCU control and to initiate an integrated self-test procedure that automatically checks and logs the condition of each channel.
- The OCUs are totally protected against high-voltage transients and are suitable for use in harsh environments.

Equipment Cabinet

- The Equipment Cabinet consist of central processing unit (CPU), switch to connect OCU and inputs for 4 - 20 mA signal. It also has an option to include an OCU in the box
- Embedded processors format the data and provides a real-time display of the partial discharge activity.
- The CPU receives the optical data streams from the OCU's and transmits control signals back to the OCU (i.e. for the self test).



System software



Touch interface (showing PD display)

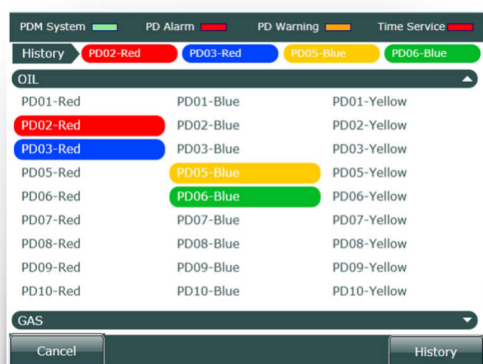

Touch interface (showing PD plot)

High clarity PD analysis, easy configuration and operation of PD events and easy access to historical data

Data handling, display and interpretation

- All single-cycle event data gathered by the sensors is automatically analyzed by a range of sophisticated software and display logics to identify the PD. At the same time, sources of interference such as lights, radar, mobile phones, motors, etc, are rejected.
- The 609-PDM system operates simultaneously in different modes and will capture isolated PD events even while displaying the current on-line data. The data can be viewed in a number of ways including POW, PRPD, PRPS, and STT format to give an instant impression of the PD characteristics.
- For the remote operation of the system, a duplicate PC, modem and LAN interface can be installed off-site. This enables the 609 PDM family to be operated, controlled and data received in a similar way to being present at the substation.

Key features

- 2D and 3D real time PoW, PRPD and PRPS data display and analysis
- 3D, real time single-cycle (PRPS) and PRPD display and analysis
- True PRPD, STT real time displays
- Periodic storage of point-on-wave displays for trend analysis
- Event Mode captures single events
- Data stored on hard disk for up to 10 years
- Automatic self-check of PDM with faults logged and alarmed
- Transfer of data to remote site by company LAN or Modem
- Programmable alarm criteria
- Warning of PD activity
- Alarm of high or increased PD activity
- Automatic communication of warning / alarm condition to headquarters PC
- Alarm notification using IEC 61850
- Automatic report generation (daily / weekly / monthly) as per customer needs

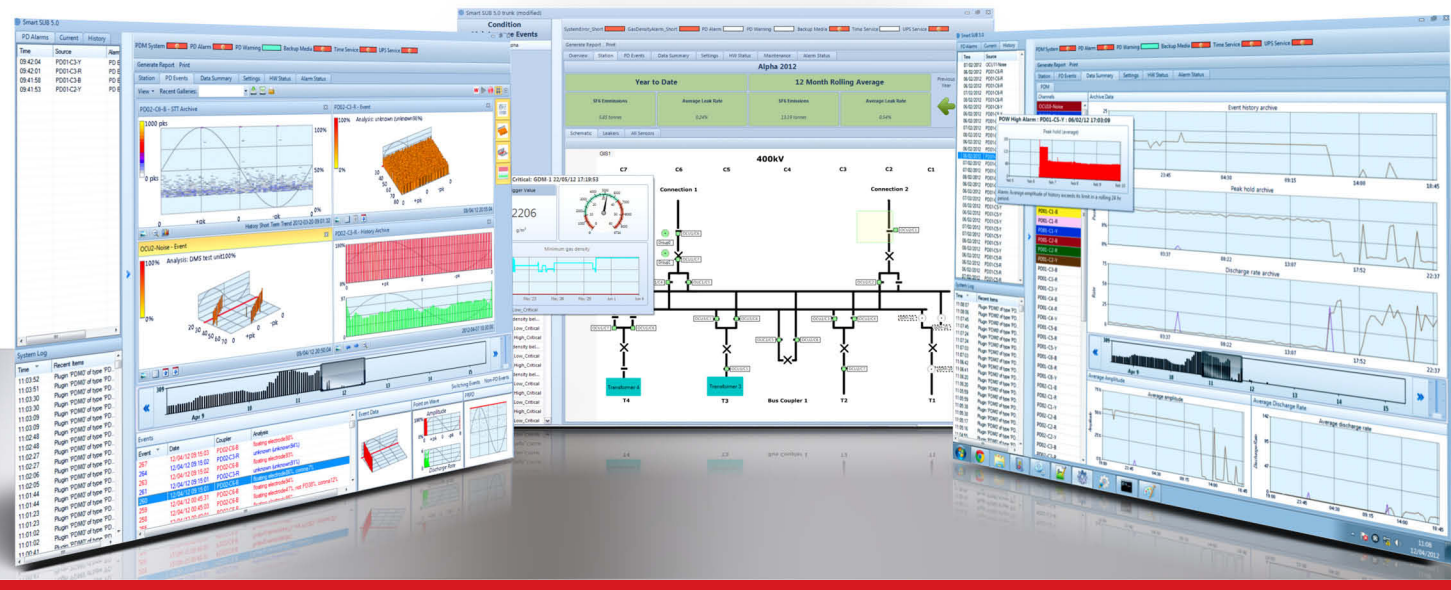

QUALITROL 609 PDM Transformer partial discharge monitor

609 PDM architecture

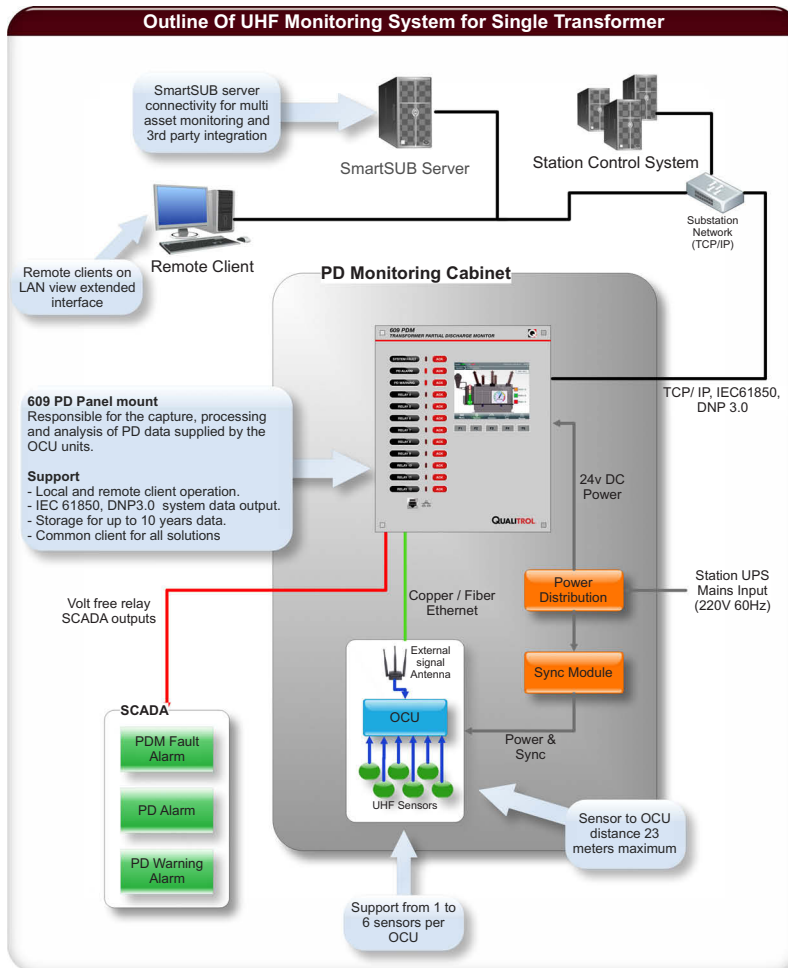

A typical 609 PDM system consists of:

- UHF sensors / couplers (internal, external, or drain valve sensors)
- 1 OCU that can support 1 to 6 sensors
- 609 main panel including central processing unit (PD monitor)
- PD analysis and reporting software

Optional:

- External OCUs that can support 1 to 6 sensors each
- Independent system enclosure for 609 base unit and one OCU
- 1 Ethernet switch (fiber-optic or copper) for each external OCU

609 PDM - full after sale support

Commissioning and calibration



- Qualitrol provides additional service and tools for calibrating sensors and commissioning the PD monitoring system
- Our staff can install, calibrate and verify proper operation of the system
- We also provide training to customer's staff on how to operate and maintain the system
- After installation, Qualitrol also provides assistance in setting up the configuration e.g. alarm limits, noise gating, drawing layout diagrams into the system etc

Training and Expert service



- Qualitrol DMS provides a training course to customers on PD measurements, analysis and how to operate and maintain the 609 PDM system
- Additional training programs are also organised for all customers to make them aware about PD measurements and analysis using our products
- Qualitrol DMS also provides detailed PD analysis service by its highly experienced and industry known experts on UHF technology. PD analysis reports can be made available periodically (on demand) based on the PD event data received from the field



TECHNICAL SPECIFICATIONS

Power supply	Voltage range	90 to 264 V AC; 47 to 63 Hz
	Supply power	70 W
	Local MMI interface	5.7" resistive touch
	Output	Three SCADA / SCS alarms contacts: PD Warning PD alarm System Fault Ethernet, IEC 61850 12 x LED status indicators (bi-colour)
MCU (Optical Converter Unit)	Input (UHF)	Supports 1 to 6 UHF channels for UHF sensor inputs
	Input (noise)	1 separate noise channel for external noise antenna
	Dynamic range	-75 to -35 dBm (logarithmic)
	Sample rate	15360 samples/s per channel at 60 Hz
UHF sensors	Mounting	Internal or External
	Output	Coaxial Analog output (N-Type)
	Bandwidth	Wideband 200 - 1500 MHz
	Sensitivity	< 5pC
Noise sensor	Gating antenna	100 - 3000 MHz
609 Base Unit PC	Memory	2 GB. Upgradable (if required)
	Minimum size for installation	20 MB
	Data storage	16 GB
	Clock	1.6 GHz
	Interference filtering	Gating, bandpass filtering, software filtering
	Reporting	Daily, weekly and monthly reports
Panel PC	Ethernet ports - external	RS-232, RJ45 (10/100 Mbps) Optional RS-485 (full duplex and half duplex)
	USB	One port to facilitate firmware upgrade, configuration upgrade and manual download of data
	Protocols	Ethernet / serial; Modbus (serial); IEC 61850
HV testing	Compatible	Ability to monitor and record PD during testing
Environmental	Ambient operating temperature	-45° to +55° C [-49° to +131° F]
	Storage temperature	-25° to +85° C [-13° to +185° F]
	Humidity	5 - 95% non-condensing
	Enclosure rating	IP66
	Seismic	IEEE C37.98 (seismic testing of relays)
	Environmental test compliance	BS EN60068-2-2, BS EN60068-2-1, BS EN60068-2-78
	Vibration test compliance	BS EN68-2-6, BS EN68-2-27, BS EN68-2-29
Immunity	EMC test compliance	Conforms to relevant specifications for monitoring / control equipment in HV substations. BS EN55022 (:2006); BS EN61000-3-2 to -3-3, BS-EN61000-4-2 to -4-6, BS EN61000-4-8, BS EN61000-4-11, BS EN61000-4-18; IEC 60255-5, IEC 61180-1
	Others	EMI / RFI immunity



609 PDM

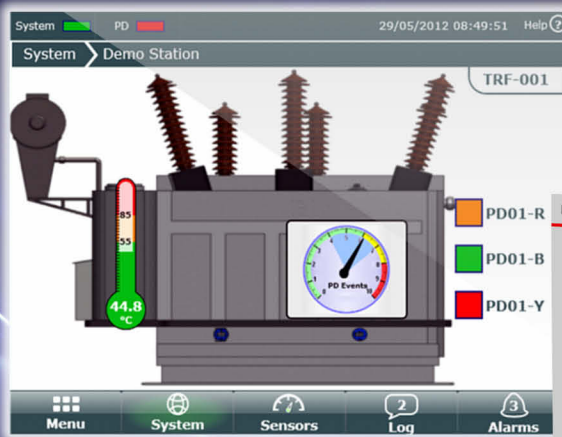
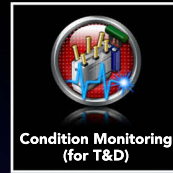

- Highly sensitive and most effective UHF PD detection
- Supports IEC 61850
- Expandable to monitor PD up to 24* power transformers simultaneously
- Excellent interference immunity for PD measurement under difficult conditions
- HV record mode, versatile sync, superior data review method
- Implementation of efficient, condition-based maintenance strategies
- Expert PD analysis and reporting by Qualitrol Experts
- Rugged and reliable design (IP66 rated)
- Reduces insurance premium of costly HV apparatus
- Smart and Quick realtime alarming / alerting mechanism

* Depending on the transformer location and monitoring sensors per transformer

About QUALITROL®

Established in 1945, with continual improvement at the core of our business, QUALITROL® provides smart utility asset condition monitoring across the globe. We are the largest and most trusted global leader for partial discharge monitoring, asset protection equipment and information products across generation, transmission and distribution. At QUALITROL® we are redefining condition monitoring technology for Electric utilities assets.

©2013 QUALITROL® Company LLC, an ISO 9001 system certified company. QUALITROL is a registered trademark and OTIWTI is a trademark of QUALITROL® Company LLC. All trademarks are properties of their respective companies, as noted herein. All rights reserved. Information subject to change without notice. PD-D27-09L-02E.